

ARK-2121V

In-Vehicle NVR w/4 PoE Ports Intel® Atom E3825 / Atom E3845 SoC Fanless Box PC



Features

- Intel® Atom E3825 Dual Core 1.33 GHz & E3845 Quad Core 1.91 GHz SoC
- 4 PoE Ports to Support Mainstream IP Cameras
- Isolated COM ports and DIO
- Diversity Communication Abilities, ex. WWAN, WLAN
- Built-in GPS and G-Sensor for GIS application
- Intelligent Vehicle Power Ignition
- 9 ~ 36 V_{DC}* Wide Power Input w/isolation
- 1 x Removable 2.5" drive bay
- Supports iManager, SUSIAccess and Embedded Software APIs
- Up to -40 ~ 70° C wide temperature support (by project)

Specifications

		ARK-2121V-S9A1E	ARK-2121V-S3A1E
Processor System	CPU	Intel Atom E3845 QC SoC	Intel Atom E3825 DC SoC
	Frequency	1.91 GHz	1.33 GHz
	L2 Cache	2 MB	1 MB
	BIOS	AMI EFI 64 Mbit	
Memory	Technology	DDR3L 1333 MHz	DDR3L 1066 MHz
	Max. Capacity	8 GB	
	Socket	1 x 204-pin SO-DIMM	
Graphics	Chipset	Intel Gen7 Graphics	
	Graphic Engine	DirectX11, OpenGL3.2, OpenCL1.1 Full HW acceleration, decode: H.264, MPEG2/4, VC-1, WMV9. Encode: H.264, MPEG2	
	VGA	Up to 2560 x 1600 @ 60Hz	
	HDMI	Lockable HDMI connector, up to 1080p	
Audio	Main System	Realtek ALC885S, High Definition Audio (HD), Line-in, Line out, Mic-in	
Ethernet	LAN #1	10/100/1000 Mbps Intel I210-IT GbE, support Wake on LAN	
	LAN #2	10/100/1000 Mbps Intel I210-IT GbE, support Wake on LAN	
I/O Interface	Power over Ethernet, PoE	4 x 10/100 Mbps - 4ports full-load, IEEE802.3af Class 2 (7Watt) - 2ports full-load, IEEE802.3af Class 3 (15.4Watt)	N/A
	Serial Ports	N/A	2 x RS-232/422/485 ports w/ 3KV isolation (support auto flow control, jumper selectable)
	Optional COM or CANBus	2 x DB9 connectors for RS-232/422/485 signal (Default) or CANBus 2.0A/B (Module option)	
	GPIO	6 x DI & 2 x DO w/ 3KV isolation Input Voltage: 0 to 30 V _{DC} , Output Current: Max. 500 mA per channel On-state Voltage: 24 V _{DC} nominal, open collector to 30 V _{DC}	
	USB	3 x USB 2.0 & 1 x USB3.0	
Other	GPS	On board standalone GPS, support GPS, GLONASS and QZSS signals	
	G-Sensor	On board high resolution G-Sensor, up to 13-bit resolution at ± 16g	
	Watchdog timer	255-level timer interval, setup by software	
Expansion	Mini PCIe #1	Full-size Mini PCIe, support mSATA	
	Mini PCIe #2	Full-size Mini PCIe, support WLAN module	
	Mini PCIe #3/4	2 x Full-size Mini PCIe w/SIM holders, support WWAN module. (USB interface)	
Storage	2.5" Drive Bay	1 x removable 2.5" drive bay (Max 9.5mm height)	
	mSATA	Leverage MiniPCIe #1 slot	
Software Support	Microsoft Windows	WES8, WES7, Windows 8, Windows 7	
	Linux	Support by project	
Power Requirement	Power Type	ATX/AT	
	Power Input Voltage*	9 ~ 36 V _{DC} w/isolation	
	Vehicle Power Ignition	Selectable boot-up & shut-down voltage, on/off delay time	
	Isolation	1.5KV Isolated	
Mechanical	Construction	Aluminum housing, Silver	
	Mounting	Din-Rail mounting, Desk/wall-mounting, VESA mounting	
	Dimensions (W x H x D)	264.5 x 69.2 x 133.0 mm	
Environment	Operating Temperature	With extended temperature peripherals: -30 ~ 60° C with 0.7m/s air flow (standard) -40 ~ 70° C with 0.7m/s air flow (by project)	With extended temperature peripherals: -30 ~ 70° C with 0.7m/s air flow (standard) -40 ~ 70° C with 0.7m/s air flow (by project)
	Storage Temperature	With standard temperature peripherals: 0 ~ 45° C with 0.7m/s air flow	
	Relative Humidity	-40 ~ 85° C (-40~185° F)	
	Vibration/Shock	95% @ 40° C (non-condensing)	
		With mSATA/SSD: IEC 60721-3-5 Class 5M3	
Regulation	EMC	CE/FCC Class A, CCC, BSMI	
	Safety	UL, CCC, BSMI, E-Mark (E13)	
	In-Vehicle Power	ISO7637-2 Lev.4	

* Power Input Constraint at low voltage: 9~10.9V.

Dimensions

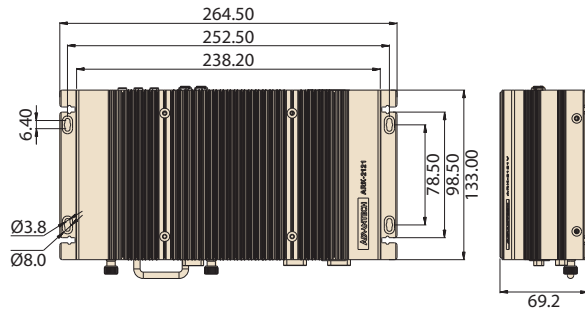

DIN Rail

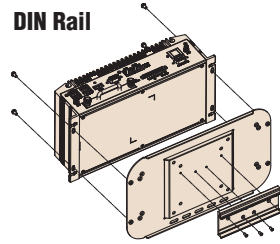

Unit: mm

VESA mount

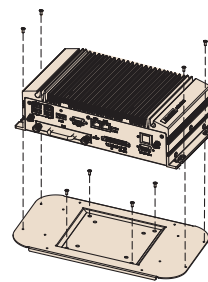

Wall mount

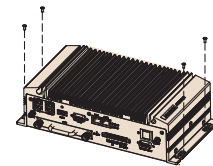

ARK-2121V-S3A1E External I/O Mechanical Layout/Drawing

Front Panel

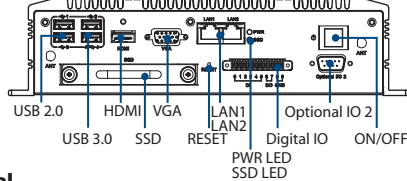

Rear Panel

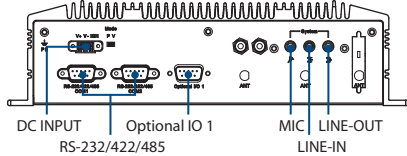

ARK-2121V-S9A1E External I/O Mechanical Layout/Drawing

Front Panel

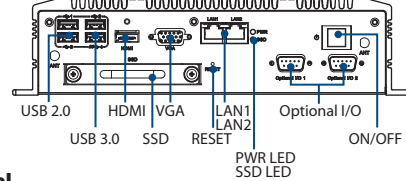

Rear Panel

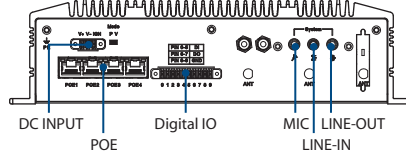

Ordering Information

Part Number	Intel CPU	RAM	2.5" Drive	mSATA	Display	GbE	PoE	USB	DIO	Optional COM or CANBus	RS-232/422/485	MiniPCIe	SIM Holder	Power Input	Operating Temperature
ARK-2121V-S3A1E	Intel Atom E3825 DC 1.33 GHz	Up to 8GB	1	1	1 x HDMI 1 x VGA	2	N/A	3 x USB2.0 1 x USB3.0	6Di 2Do	2 x RS-232/422/485 or 2 x CANBus 2.0A.B	2	4 x Full Size	2	9 ~ 36 Vdc	-30 ~ 70° C
ARK-2121V-S9A1E	Intel Atom E3845 QC 1.91 GHz	8GB	1	1	1 x HDMI 1 x VGA	2	4	3 x USB2.0 1 x USB3.0	6Di 2Do	2 x RS-232/422/485 or 2 x CANBus 2.0A.B	N/A	4 x Full Size	2	9 ~ 36 Vdc	-30 ~ 60° C

Packing List

Part Number	Description
-	1 x ARK-2121 Unit
-	1 x Driver/Utility CD/Manual
-	1 x User Manual (Simplified Chinese)
1652000049	3-pole phoenix power block 3.81mm
1750001782	1 x GPS antenna Active with 5M SMA cable
1652003235	10-Pin DIO plug in block

Optional Items

Part Number	Description
96PSA-A120W19T2	AC-to-DC Adapter
1702002600	Power Cable 3-pin 180cm, USA type
1702002605-02	Power Cable 3-pin 183cm, Europe type
1700018704	Power Cable 3-pin 183cm, UK type
AMK-V004E	VESA mounting kit
AMK-R004E	DIN-rail mounting kit

Embedded OS

Part Number	Description
2070013555	ARK-2121V-S3A1E WES7 E OS image
2070013559	ARK-2121V-S9A1E WES7 E OS image
2070013597	ARK-2121V-S3A1E WE8S OS image
2070013598	ARK-2121V-S9A1E WE8S OS image

*Default BIOS is supported for 64-bit OS installation, BIOS 32-bit OS is supported by project